

OWNER :

APPROVED BY :

PROJECT :

LOCATION :

PRESENTED BY :

ANDEN CORPORATION COMPANY LIMITED  
10/22, 10/23 Prawat Lae Phuean Alley,  
Lat Yao, Chatuchak, Bangkok 10900,  
Thailand

DESIGNED BY :

INTERIOR  
DESIGNER

CIVIL  
ENGINEER

MECHANIC  
ENGINEER

ELECTRICAL  
ENGINEER

SYSTEM  
DESIGNER

DRAWN BY

DESIGN DRAWING

TITLE :

SCALE

REVISION

DATE

DRAWING NO. :

SHEET NO. :



พื้นที่ติดตั้ง

ขนาด

พื้นที่ติดตั้งที่เหมาะสม

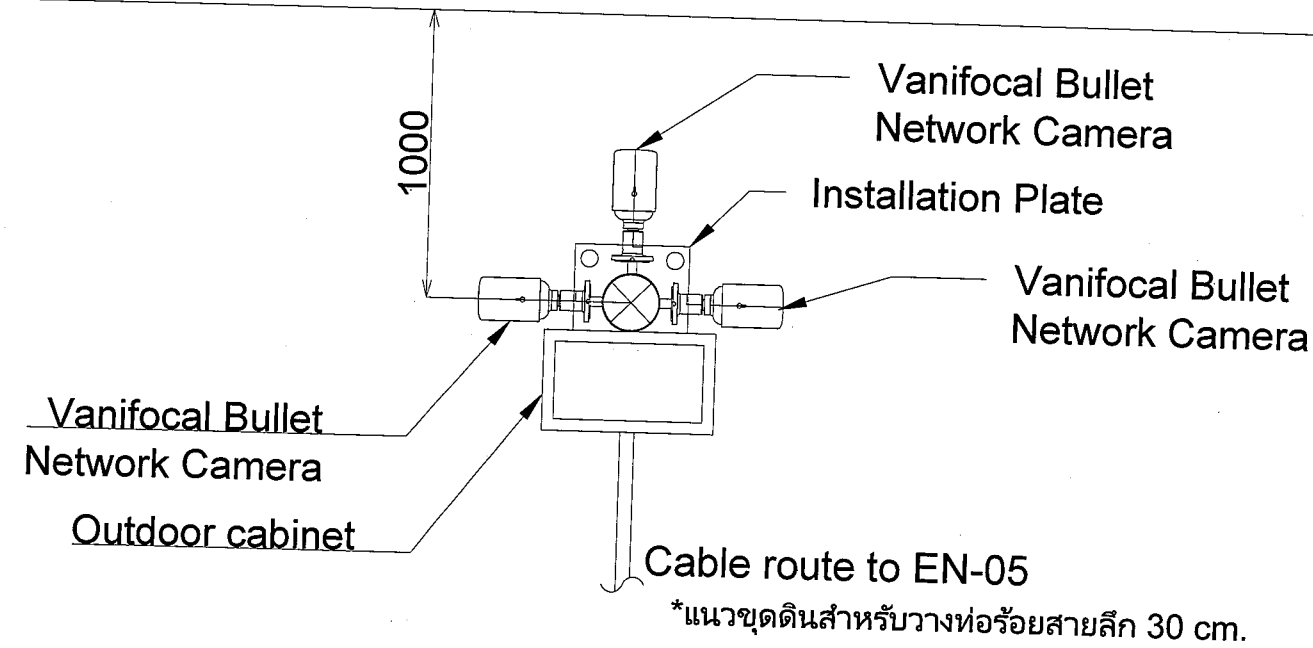

Note: ปรับพื้นที่ติดตั้งให้เหมาะสมสำหรับการติดตั้งเสาจับยึด

# MRS-4

THE DESIGN AND SPECIFICATION AS PRESENTED IN THIS DRAWING ARE PROPERTIES OF ANDEN CORPORATION CO., LTD. THEY ARE NOT ALLOWED TO BE USED WITHOUT PRIOR WRITTEN PERMISSION

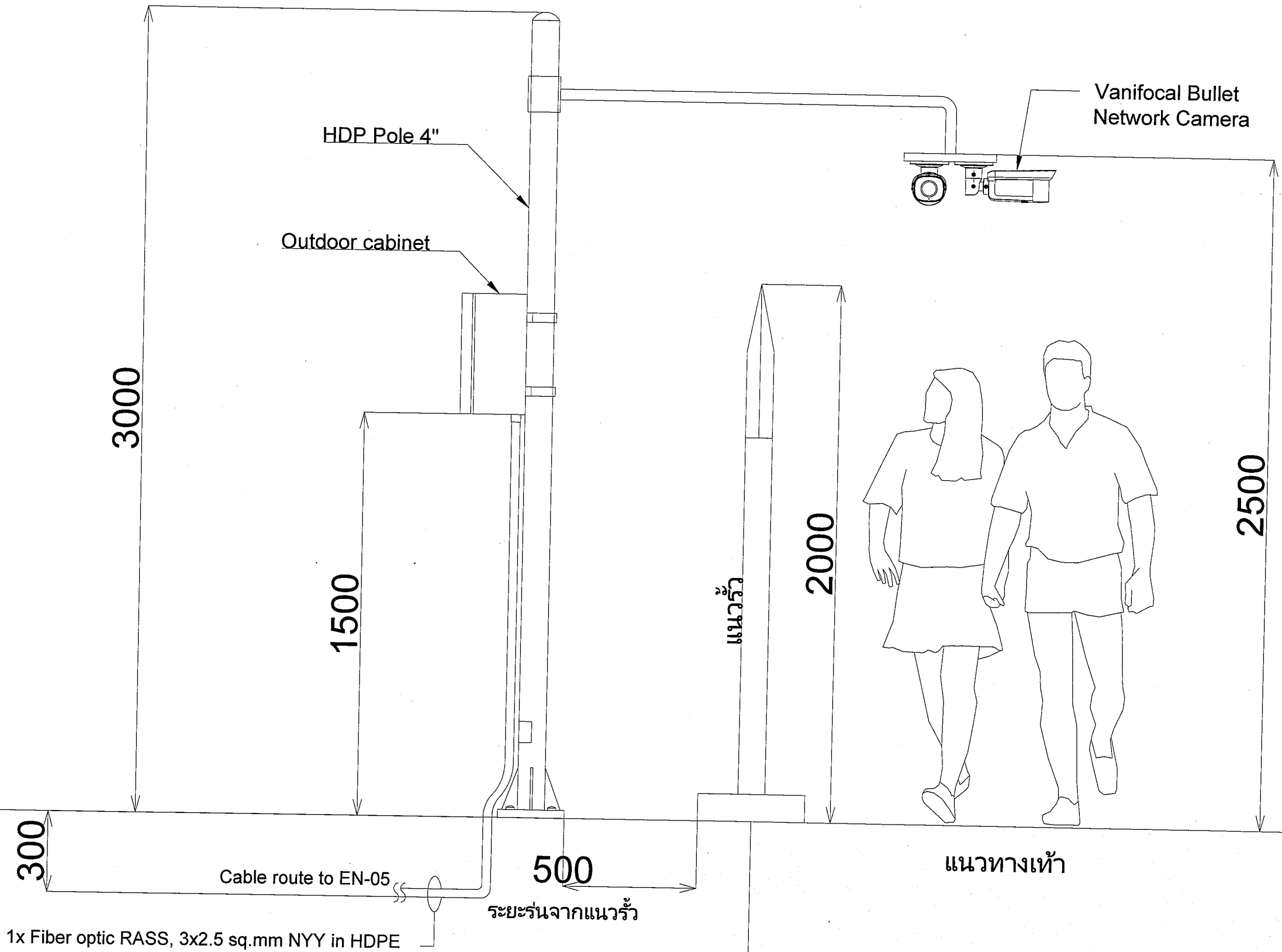

1x Fiber optic RASS, 3x2.5 sq.mm NYY in HDPE

Note: ปรับพื้นที่ติดตั้งให้เหมาะสมสำหรับการติดตั้งเสาจับยึด

OWNER :	
APPROVED BY :	
PROJECT :	
LOCATION :	
PRESENTED BY :	
ANDEN CORPORATION COMPANY LIMITED 10/22, 10/23 Prawit Loe Phueon Alley, Lat Yao, Chatuchak, Bangkok 10900, Thailand	
DESIGNED BY :	
INTERIOR DESIGNER	
CIVIL ENGINEER	
MECHANIC ENGINEER	
ELECTRICAL ENGINEER	
SYSTEM DESIGNER	
DRAWN BY	
DESIGN DRAWING	
TITLE :	
SCALE	
REVISION	
DATE	
DRAWING NO. :	
SHEET NO. :	

THE DESIGN AND SPECIFICATION AS PRESENTED IN THIS DRAWING ARE PROPERTIES OF ANDEN CORPORATION CO., LTD. THEY ARE NOT ALLOWED TO BE USED WITHOUT PRIOR WRITTEN PERMISSION

คอนกรีต

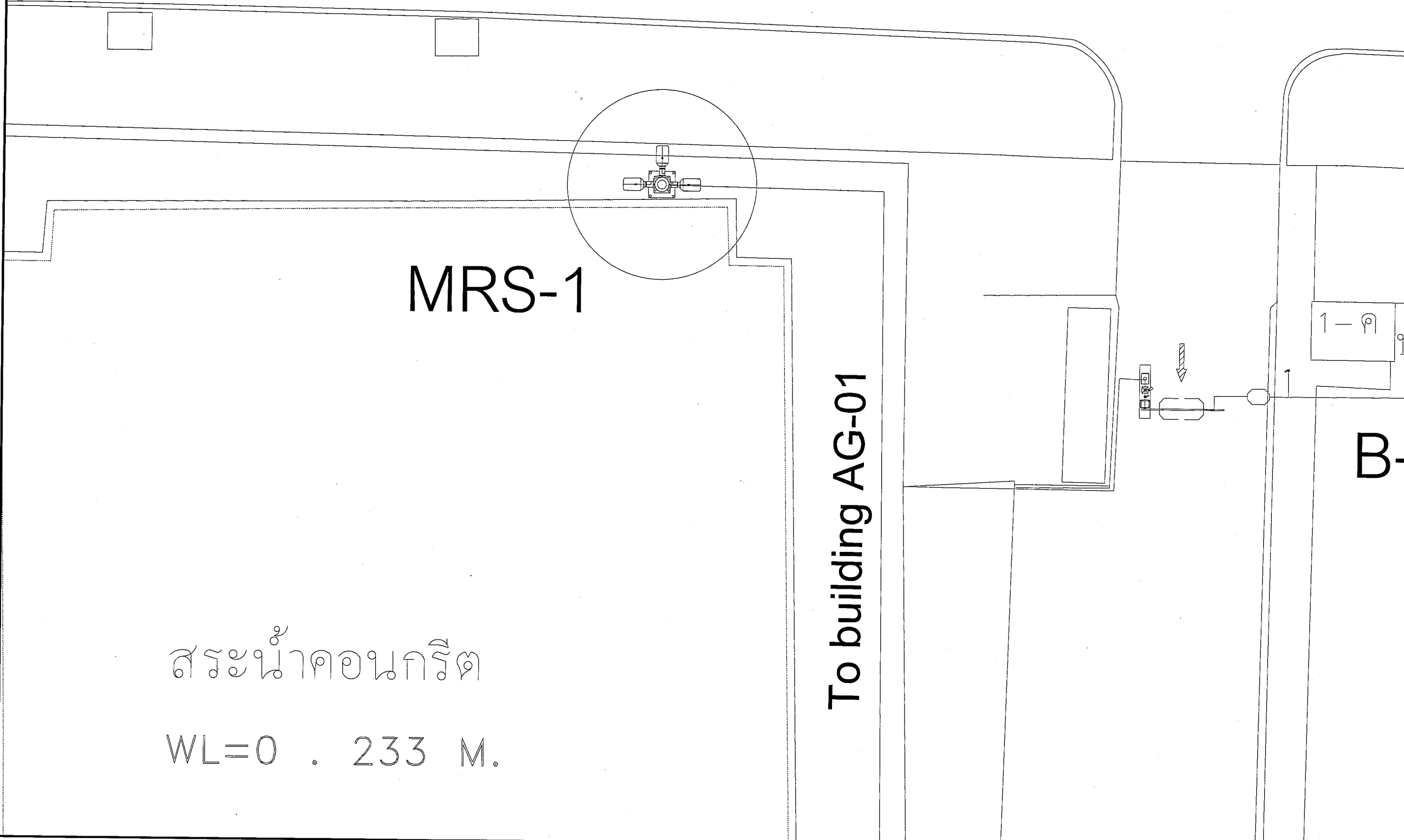

MRS-1

To building AG-01

สระน้ำคอนกรีต

WL=0 . 233 M.

OWNER :

APPROVED BY :

PROJECT :

LOCATION :

PRESENTED BY :

ANDEN CORPORATION COMPANY LIMITED  
10/22, 10/23 Prowit Lae Phuean Alley,  
Lat Yao, Chatuchak, Bangkok 10900,  
Thailand

DESIGNED BY :

INTERIOR  
DESIGNER

CIVIL  
ENGINEER

MECHANIC  
ENGINEER

ELECTRICAL  
ENGINEER

SYSTEM  
DESIGNER

DRAWN BY

DESIGN DRAWING

TITLE :

SCALE

REVISION

DATE

DRAWING NO. :

SHEET NO. :

THE DESIGN AND SPECIFICATION AS PRESENTED IN THIS DRAWING ARE PROPERTIES OF ANDEN CORPORATION CO., LTD. THEY ARE NOT ALLOWED TO BE USED WITHOUT PRIOR WRITTEN PERMISSION

# DC KDMC

พื้นที่ก่อสร้าง

5-ค  
สำนักงานวิจัยและบริการคอมพิวเตอร์

บ่อน้ำ  
=2 367 M.

MRS-2

สถานีโรงไฟฟ้า

โรงจอดรถ

โรงจอดรถ

โรงจอดรถ

โรงจอดรถ

286 M.

ถนนลาดยาง

บ่อพักสายไฟ

ศาลพระภูมิ

บ่อขาม

OWNER :

APPROVED BY :

PROJECT :

LOCATION :

PRESENTED BY :

ANDEN CORPORATION COMPANY LIMITED  
10/22, 10/23 Prawat Lae Phuean Alley,  
Lat Yao, Chatuchak, Bangkok 10900,  
Thailand

DESIGNED BY :

INTERIOR DESIGNER	
CIVIL ENGINEER	
MECHANIC ENGINEER	
ELECTRICAL ENGINEER	
SYSTEM DESIGNER	
DRAWN BY	

DESIGN DRAWING

TITLE :

SCALE

REVISION

DATE

DRAWING NO. :

SHEET NO. :

THE DESIGN AND SPECIFICATION AS PRESENTED IN THIS DRAWING ARE PROPERTIES OF ANDEN CORPORATION CO., LTD. THEY ARE NOT ALLOWED TO BE USED WITHOUT PRIOR WRITTEN PERMISSION

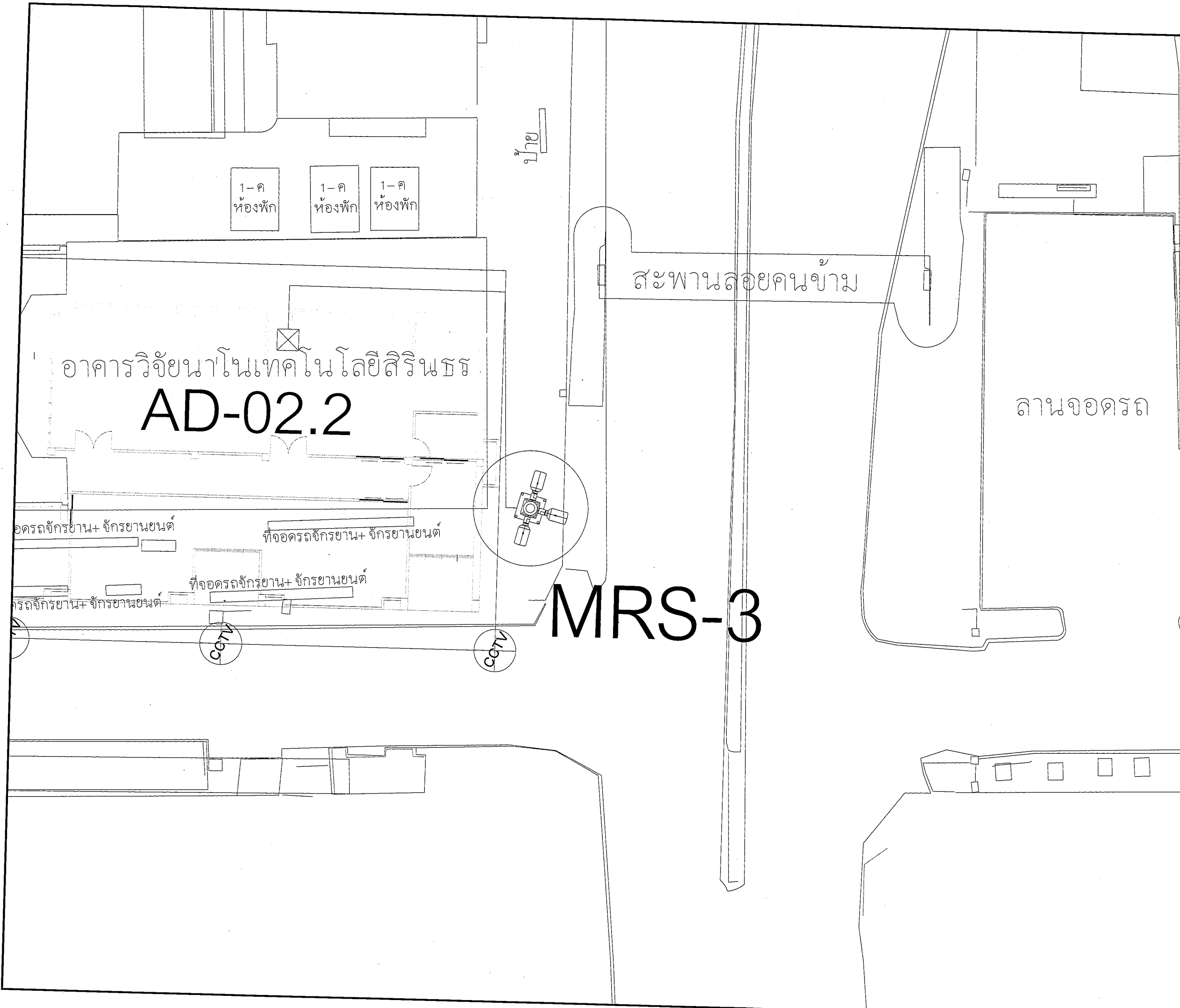

OWNER :

APPROVED BY :

PROJECT :

LOCATION :

PRESENTED BY :

ANDEN CORPORATION COMPANY LIMITED  
10/22, 10/23 Prawat Lae Phuean Alley,  
Lat Yao, Chatuchak, Bangkok 10900,  
Thailand

DESIGNED BY :

INTERIOR  
DESIGNER

CIVIL  
ENGINEER

MECHANIC  
ENGINEER

ELECTRICAL  
ENGINEER

SYSTEM  
DESIGNER

DRAWN BY

DESIGN DRAWING

TITLE :

SCALE

REVISION

DATE

DRAWING NO. :

SHEET NO. :

THE DESIGN AND SPECIFICATION AS PRESENTED IN THIS DRAWING ARE PROPERTIES OF ANDEN CORPORATION CO., LTD. THEY ARE NOT ALLOWED TO BE USED WITHOUT PRIOR WRITTEN PERMISSION

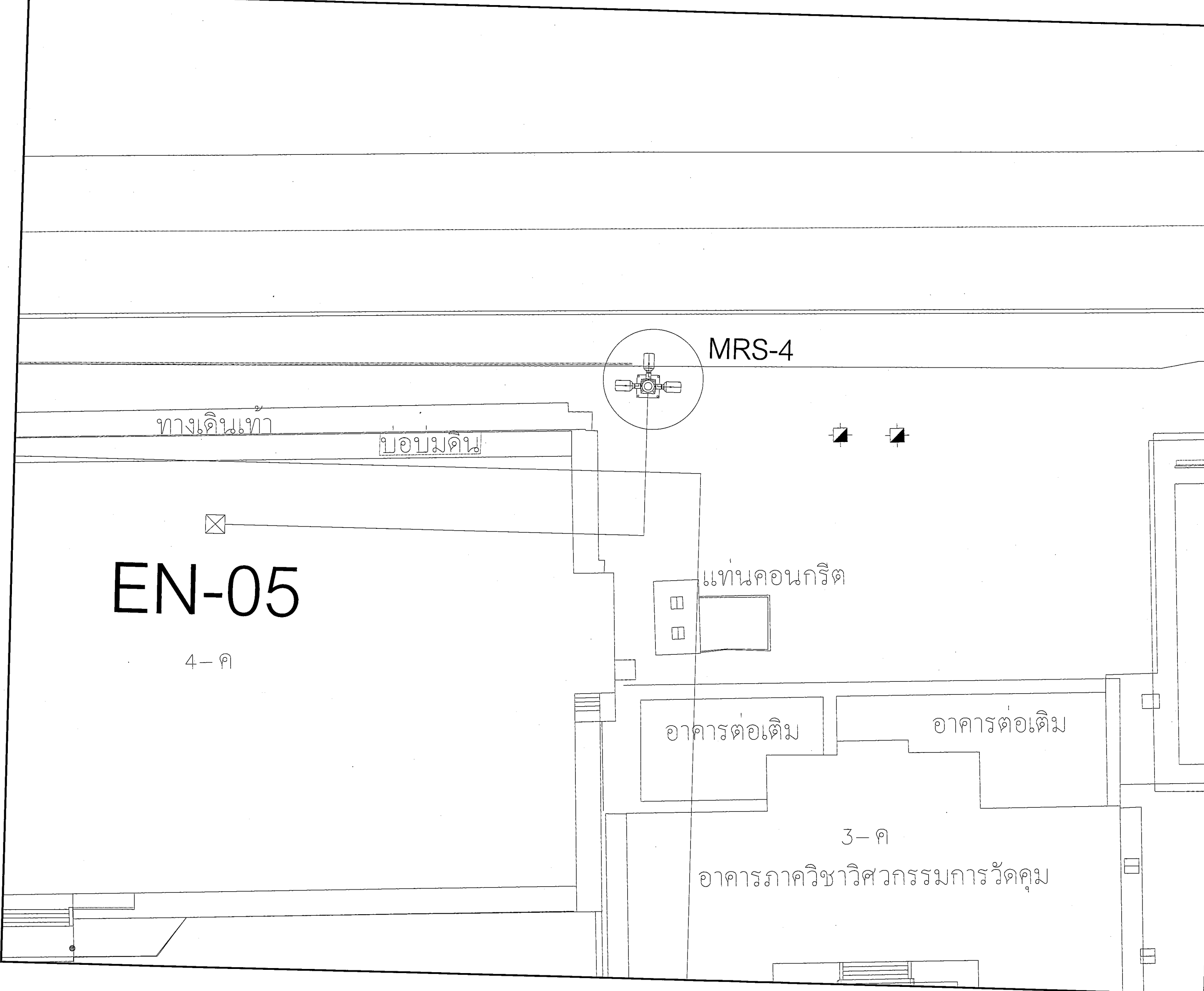

OWNER :

APPROVED BY :

PROJECT :

LOCATION :

PRESENTED BY :

ANDEN CORPORATION COMPANY LIMITED  
 10/22, 10/23 Prawit Lae Phuean Alley,  
 Lat Yao, Chatuchak, Bangkok 10900,  
 Thailand

DESIGNED BY :

INTERIOR DESIGNER	
CIVIL ENGINEER	
MECHANIC ENGINEER	
ELECTRICAL ENGINEER	
SYSTEM DESIGNER	
DRAWN BY	

DESIGN DRAWING

TITLE :

SCALE	
REVISION	
DATE	

DRAWING NO. :

SHEET NO. :

THE DESIGN AND SPECIFICATION AS PRESENTED IN THIS DRAWING ARE PROPERTIES OF ANDEN CORPORATION CO., LTD. THEY ARE NOT ALLOWED TO BE USED WITHOUT PRIOR WRITTEN PERMISSION

OWNER :

APPROVED BY :

PROJECT :

LOCATION :

PRESENTED BY :

ANDEN CORPORATION COMPANY LIMITED  
10/22, 10/23 Prawat Lae Phuean Alley,  
Lat Yao, Chatuchak, Bangkok 10900,  
Thailand

DESIGNED BY :

INTERIOR  
DESIGNER

CIVIL  
ENGINEER

MECHANIC  
ENGINEER

ELECTRICAL  
ENGINEER

SYSTEM  
DESIGNER

DRAWN BY

DESIGN DRAWING

TITLE :

SCALE

REVISION

DATE

DRAWING NO. :

SHEET NO. :

B-1

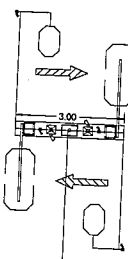

1-ค  
ปั๊มน้ำ

To building IA-01

1-ค  
ปั๊มน้ำ

บ่อน้ำ

WL = -0 . 222 M.

THE DESIGN AND SPECIFICATION AS PRESENTED IN THIS DRAWING ARE PROPERTIES OF ANDEN CORPORATION CO., LTD. THEY ARE NOT ALLOWED TO BE USED WITHOUT PRIOR WRITTEN PERMISSION



To building AG-01

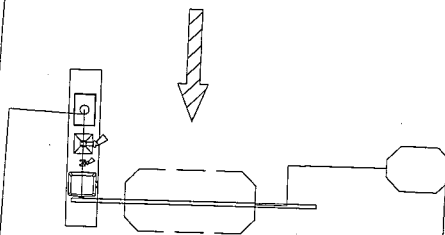

1-ค บ่อมยาม

B-2

OWNER :

APPROVED BY :

PROJECT :

LOCATION :

PRESENTED BY :

ANDEN CORPORATION COMPANY LIMITED  
10/22, 10/23 Prawat Lee Phuean Alley,  
Lat Yao, Chatuchak, Bangkok 10900,  
Thailand

DESIGNED BY :

INTERIOR  
DESIGNER

CIVIL  
ENGINEER

MECHANIC  
ENGINEER

ELECTRICAL  
ENGINEER

SYSTEM  
DESIGNER

DRAWN BY

DESIGN DRAWING

TITLE :

SCALE

REVISION

DATE

DRAWING NO. :

SHEET NO. :

THE DESIGN AND SPECIFICATION AS PRESENTED IN THIS DRAWING ARE PROPERTIES OF ANDEN CORPORATION CO., LTD. THEY ARE NOT ALLOWED TO BE USED WITHOUT PRIOR WRITTEN PERMISSION

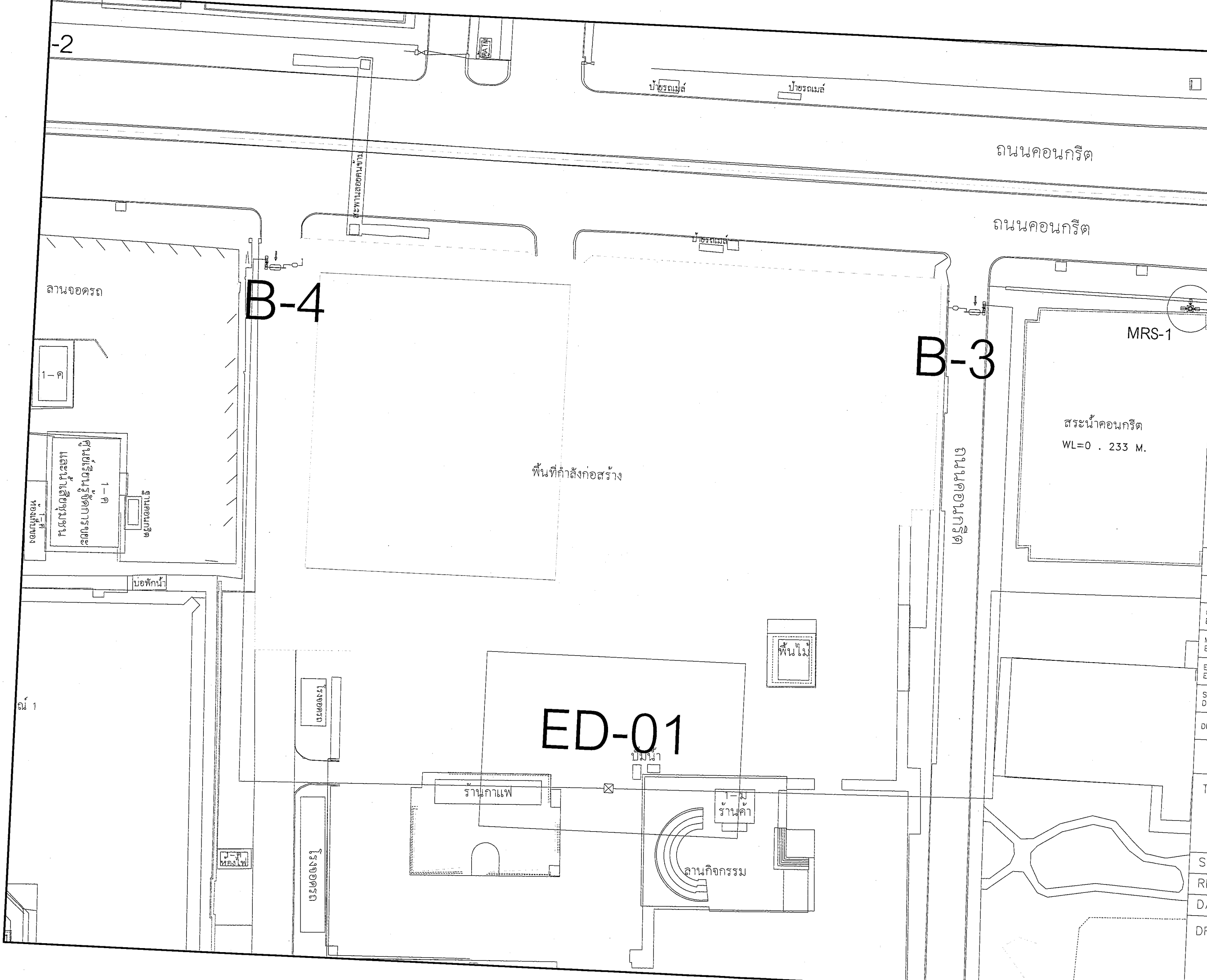

OWNER :

APPROVED BY :

PROJECT :

LOCATION :

PRESENTED BY :

ANDEN CORPORATION COMPANY LIMITED  
 10/22, 10/23 Prawat Lae Phuean Alley,  
 Lat Yao, Chatuchak, Bangkok 10900,  
 Thailand

DESIGNED BY :

INTERIOR DESIGNER	
CIVIL ENGINEER	
MECHANIC ENGINEER	
ELECTRICAL ENGINEER	
SYSTEM DESIGNER	
DRAWN BY	

DESIGN DRAWING

TITLE :

SCALE

REVISION

DATE

DRAWING NO. :

SHEET NO. :

THE DESIGN AND SPECIFICATION AS PRESENTED IN THIS DRAWING ARE PROPERTIES OF ANDEN CORPORATION CO., LTD. THEY ARE NOT ALLOWED TO BE USED WITHOUT PRIOR WRITTEN PERMISSION

โดยีการเกษตร

1-ค

ป้อมยาม

To building AG-01

B-5

ศาลพระภูมิ

OWNER :

APPROVED BY :

PROJECT :

LOCATION :

PRESENTED BY :

ANDEN CORPORATION COMPANY LIMITED  
10/22, 10/23 Prawat Lae Phuean Alley,  
Lat Yao, Chatuchak, Bangkok 10900,  
Thailand

DESIGNED BY :

INTERIOR  
DESIGNER

CIVIL  
ENGINEER

MECHANIC  
ENGINEER

ELECTRICAL  
ENGINEER

SYSTEM  
DESIGNER

DRAWN BY

DESIGN DRAWING

TITLE :

SCALE

REVISION

DATE

DRAWING NO. :

SHEET NO. :

THE DESIGN AND SPECIFICATION AS PRESENTED IN THIS DRAWING ARE PROPERTIES OF ANDEN CORPORATION CO., LTD. THEY ARE NOT ALLOWED TO BE USED WITHOUT PRIOR WRITTEN PERMISSION

To building LI-02

919116

C-1

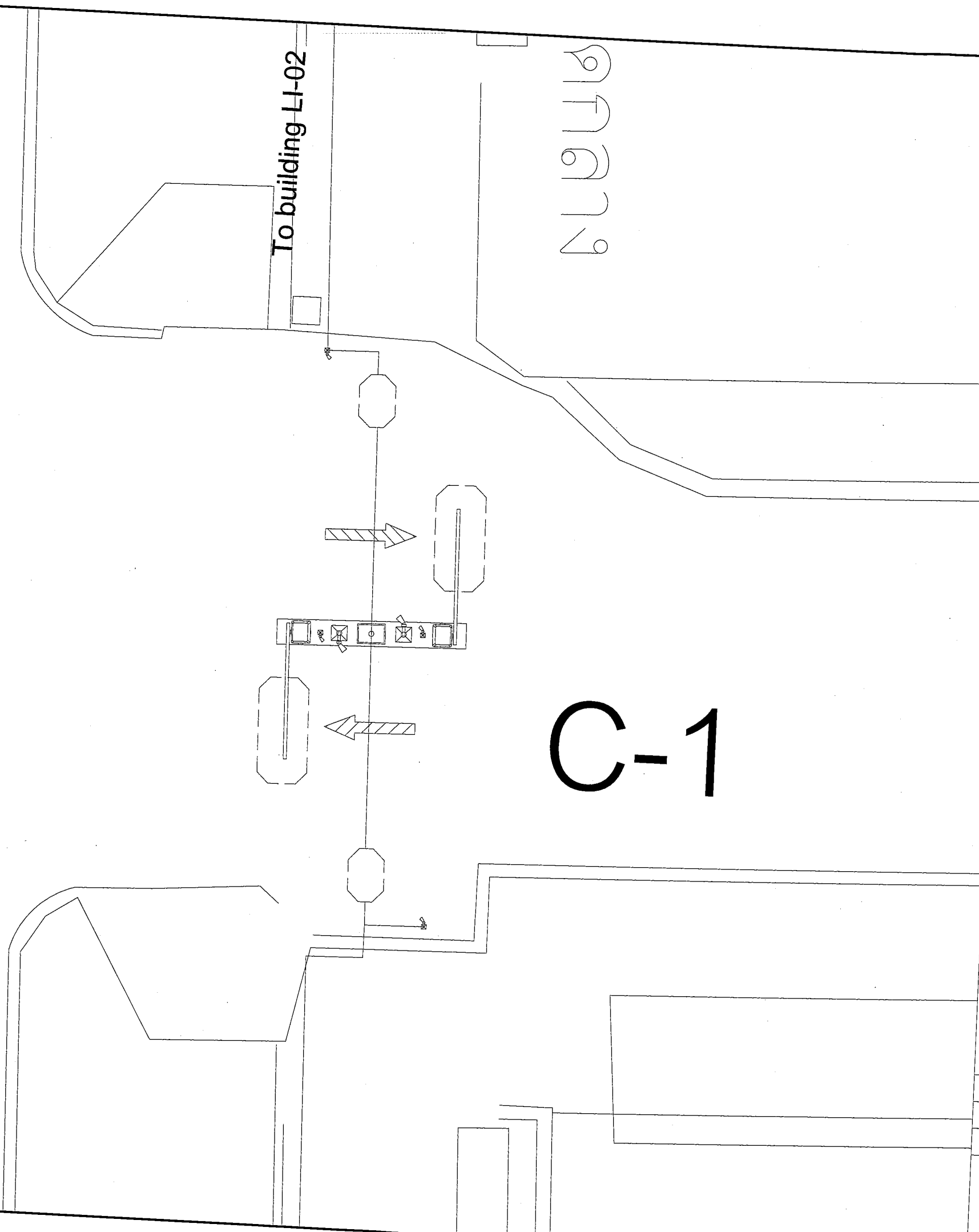

OWNER :

APPROVED BY :

PROJECT :

LOCATION :

PRESENTED BY :

ANDEN CORPORATION COMPANY LIMITED  
10/22, 10/23 Prawit Lae Phuean Alley,  
Lat Yao, Chatuchak, Bangkok 10900,  
Thailand

DESIGNED BY :

INTERIOR DESIGNER

CIVIL ENGINEER

MECHANIC ENGINEER

ELECTRICAL ENGINEER

SYSTEM DESIGNER

DRAWN BY

DESIGN DRAWING

TITLE :

SCALE

REVISION

DATE

DRAWING NO. :

SHEET NO. :

THE DESIGN AND SPECIFICATION AS PRESENTED IN THIS DRAWING ARE PROPERTIES OF ANDEN CORPORATION CO., LTD. THEY ARE NOT ALLOWED TO BE USED WITHOUT PRIOR WRITTEN PERMISSION

To building LI-02

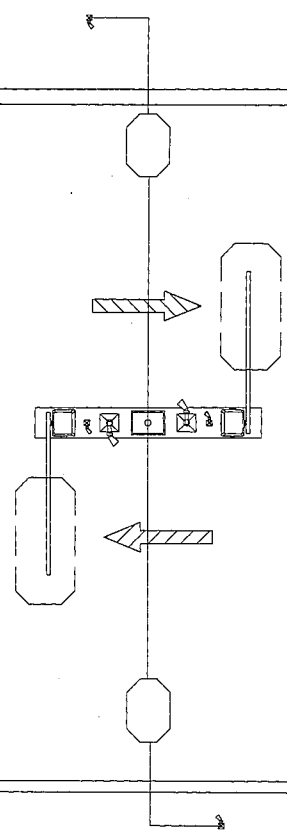

C-2

OWNER :

APPROVED BY :

PROJECT :

LOCATION :

PRESENTED BY :

ANDEN CORPORATION COMPANY LIMITED  
10/22, 10/23 Prawat Lae Phuean Alley,  
Lat Yao, Chatuchak, Bangkok 10900,  
Thailand

DESIGNED BY :

INTERIOR  
DESIGNER

CIVIL  
ENGINEER

MECHANIC  
ENGINEER

ELECTRICAL  
ENGINEER

SYSTEM  
DESIGNER

DRAWN BY

DESIGN DRAWING

TITLE :

SCALE

REVISION

DATE

DRAWING NO. :

SHEET NO. :

THE DESIGN AND SPECIFICATION AS PRESENTED IN THIS DRAWING ARE PROPERTIES OF ANDEN CORPORATION CO., LTD. THEY ARE NOT ALLOWED TO BE USED WITHOUT PRIOR WRITTEN PERMISSION

ร ม เกษตร

โล ยี การ เกษ ตร

C-3

C-4

To building AG-31

To C-3

To C-4

OWNER :

APPROVED BY :

PROJECT :

LOCATION :

PRESENTED BY :

ANDEN CORPORATION COMPANY LIMITED  
10/22, 10/23 Prawat Lae Phuean Alley,  
Lat Yao, Chatuchak, Bangkok 10900,  
Thailand

DESIGNED BY :

INTERIOR DESIGNER

CIVIL ENGINEER

MECHANIC ENGINEER

ELECTRICAL ENGINEER

SYSTEM DESIGNER

DRAWN BY

DESIGN DRAWING

TITLE :

SCALE

REVISION

DATE

DRAWING NO. :

SHEET NO. :

THE DESIGN AND SPECIFICATION AS PRESENTED IN THIS DRAWING ARE PROPERTIES OF ANDEN CORPORATION CO., LTD. THEY ARE NOT ALLOWED TO BE USED WITHOUT PRIOR WRITTEN PERMISSION

19



C-5

To building AG-38

OWNER :

APPROVED BY :

PROJECT :

LOCATION :

PRESENTED BY :

ANDEN CORPORATION COMPANY LIMITED  
 10/22, 10/23 Prawat Lae Phuean Alley,  
 Lat Yao, Chatuchak, Bangkok 10900,  
 Thailand

DESIGNED BY :

INTERIOR DESIGNER

CIVIL ENGINEER

MECHANIC ENGINEER

ELECTRICAL ENGINEER

SYSTEM DESIGNER

DRAWN BY

DESIGN DRAWING

TITLE :

SCALE

REVISION

DATE

DRAWING NO. :

SHEET NO. :

THE DESIGN AND SPECIFICATION AS PRESENTED IN THIS DRAWING ARE PROPERTIES OF ANDEN CORPORATION CO., LTD. THEY ARE NOT ALLOWED TO BE USED WITHOUT PRIOR WRITTEN PERMISSION

# D-1

To building AR-25

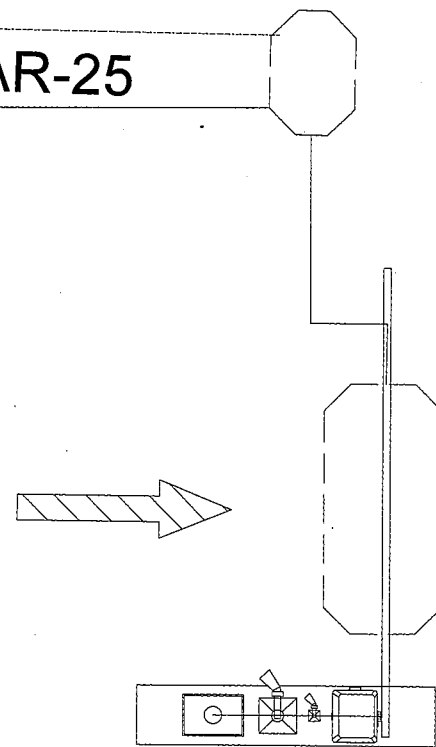

OWNER :

APPROVED BY :

PROJECT :

LOCATION :

PRESENTED BY :

ANDEN CORPORATION COMPANY LIMITED  
10/22, 10/23 Prowit Lee Phuean Alley,  
Lat Yao, Chatuchak, Bangkok 10900,  
Thailand

DESIGNED BY :

INTERIOR  
DESIGNER

CIVIL  
ENGINEER

MECHANIC  
ENGINEER

ELECTRICAL  
ENGINEER

SYSTEM  
DESIGNER

DRAWN BY

DESIGN DRAWING

TITLE :

SCALE

REVISION

DATE

DRAWING NO. :

SHEET NO. :

THE DESIGN AND SPECIFICATION AS PRESENTED IN THIS DRAWING ARE PROPERTIES OF ANDEN CORPORATION CO., LTD. THEY ARE NOT ALLOWED TO BE USED WITHOUT PRIOR WRITTEN PERMISSION



D-2

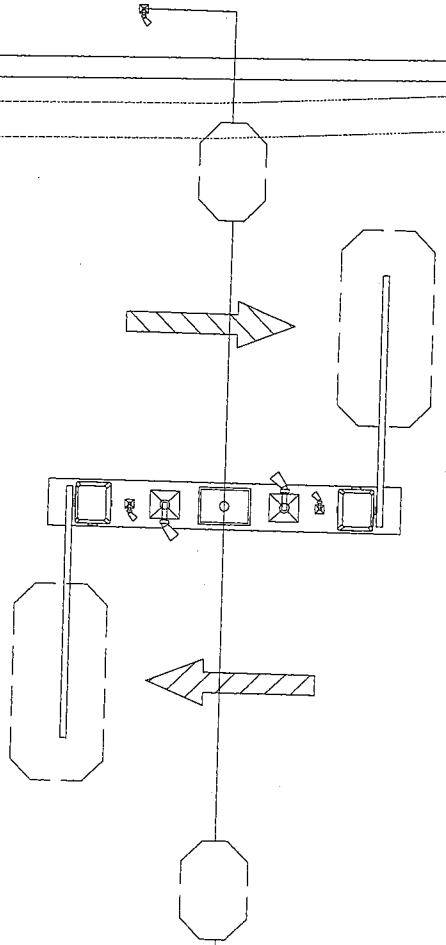

To building AR-04

OWNER :

APPROVED BY :

PROJECT :

LOCATION :

PRESENTED BY :

ANDEN CORPORATION COMPANY LIMITED  
10/22, 10/23 Prawat Lae Phuean Alley,  
Lat Yao, Chatuchak, Bangkok 10900,  
Thailand

DESIGNED BY :

INTERIOR  
DESIGNER

CIVIL  
ENGINEER

MECHANIC  
ENGINEER

ELECTRICAL  
ENGINEER

SYSTEM  
DESIGNER

DRAWN BY

DESIGN DRAWING

TITLE :

SCALE

REVISION

DATE

DRAWING NO. :

SHEET NO. :

THE DESIGN AND SPECIFICATION AS PRESENTED IN THIS DRAWING ARE PROPERTIES OF ANDEN CORPORATION CO., LTD. THEY ARE NOT ALLOWED TO BE USED WITHOUT PRIOR WRITTEN PERMISSION

To building EN-01

D-3

OWNER :

APPROVED BY :

PROJECT :

LOCATION :

PRESENTED BY :

ANDEN CORPORATION COMPANY LIMITED  
10/22, 10/23 Prawat Lae Phuean Alley,  
Lat Yao, Chatuchak, Bangkok 10900,  
Thailand

DESIGNED BY :

INTERIOR DESIGNER	
CIVIL ENGINEER	
MECHANIC ENGINEER	
ELECTRICAL ENGINEER	
SYSTEM DESIGNER	
DRAWN BY	

DESIGN DRAWING

TITLE :

SCALE

REVISION

DATE

DRAWING NO. :

SHEET NO. :

THE DESIGN AND SPECIFICATION AS PRESENTED IN THIS DRAWING ARE PROPERTIES OF ANDEN CORPORATION CO., LTD. THEY ARE NOT ALLOWED TO BE USED WITHOUT PRIOR WRITTEN PERMISSION

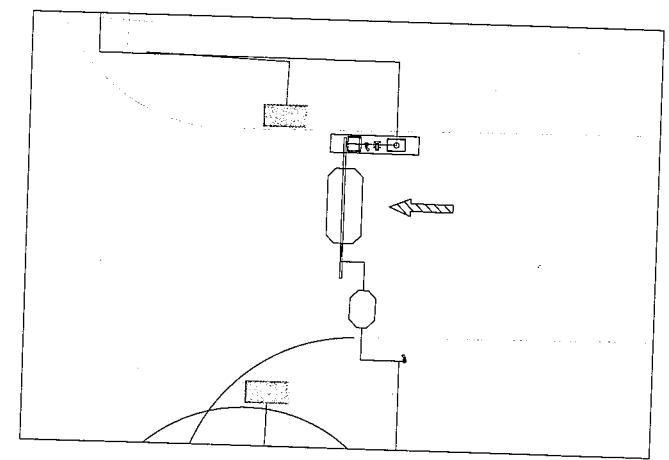
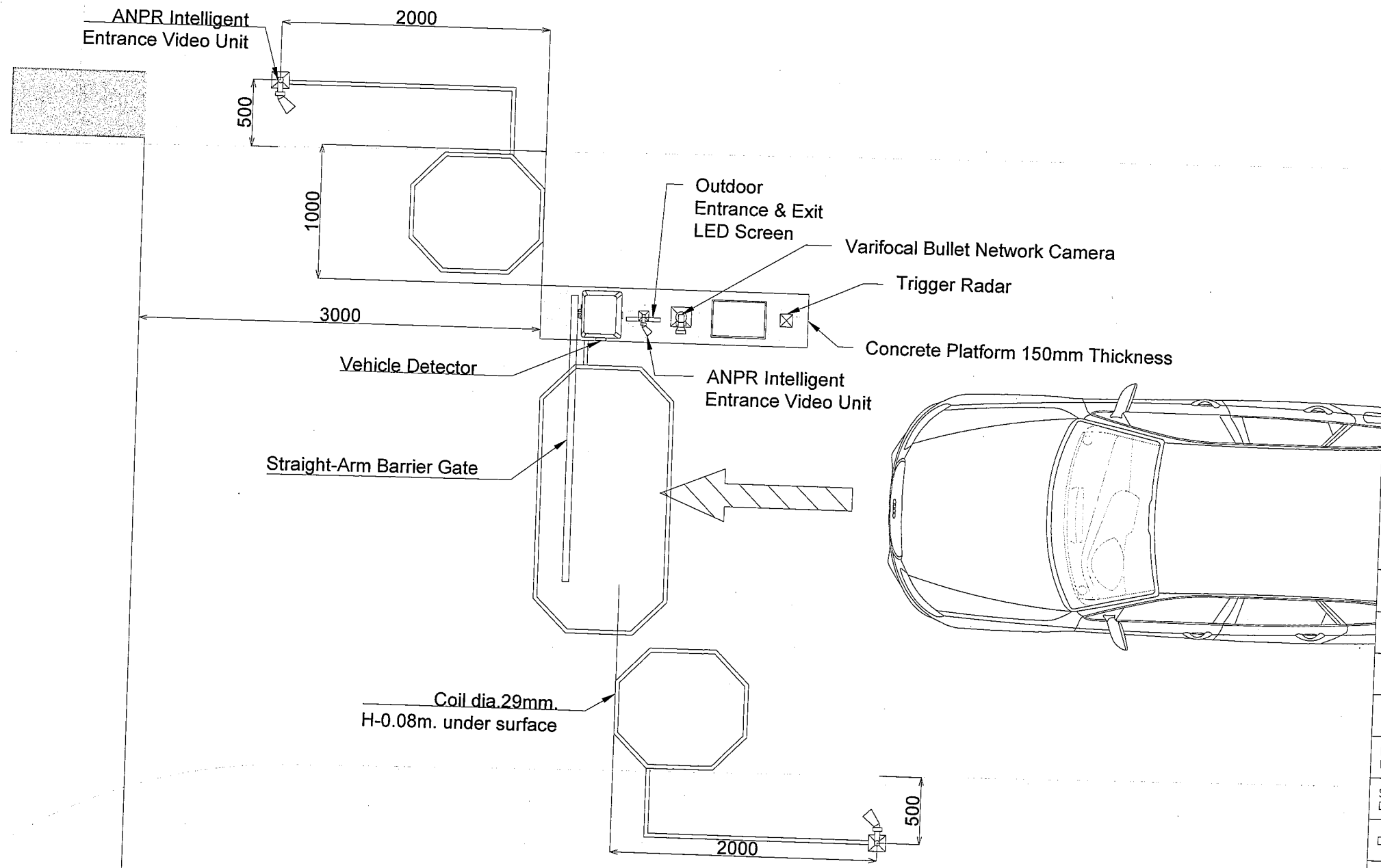

C-4

OWNER :

APPROVED BY :

PROJECT :

LOCATION :

PRESENTED BY :

ANDEN CORPORATION COMPANY LIMITED  
10/22, 10/23 Prawat Loe Phuean Alley,  
Lat Yao, Chatuchak, Bangkok 10900,  
Thailand

DESIGNED BY :

INTERIOR DESIGNER	
CIVIL ENGINEER	
MECHANIC ENGINEER	
ELECTRICAL ENGINEER	
SYSTEM DESIGNER	
DRAWN BY	

DESIGN DRAWING

TITLE :

SCALE	
REVISION	
DATE	

DRAWING NO. :

SHEET NO. :

THE DESIGN AND SPECIFICATION AS PRESENTED IN THIS DRAWING ARE PROPERTIES OF ANDEN CORPORATION CO., LTD. THEY ARE NOT ALLOWED TO BE USED WITHOUT PRIOR WRITTEN PERMISSION

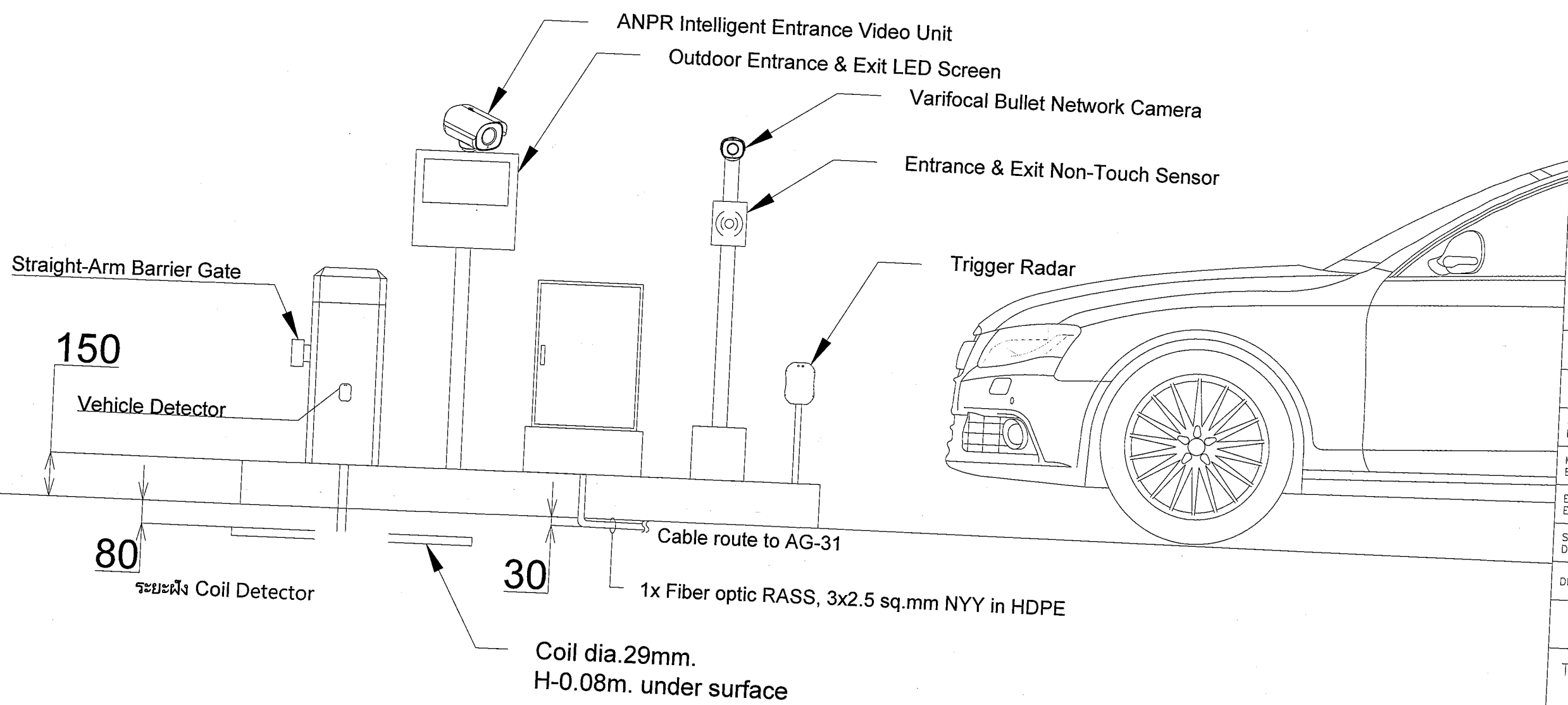

OWNER :

APPROVED BY :

PROJECT :

LOCATION :

PRESENTED BY :

ANDEN CORPORATION COMPANY LIMITED  
 10/22, 10/23 Prawat Lae Phuean Alley,  
 Lat Yao, Chatuchak, Bangkok 10900,  
 Thailand

DESIGNED BY :

INTERIOR DESIGNER	
CIVIL ENGINEER	
MECHANIC ENGINEER	
ELECTRICAL ENGINEER	
SYSTEM DESIGNER	

DRAWN BY

DESIGN DRAWING

TITLE :

SCALE	
REVISION	
DATE	

DRAWING NO. :

SHEET NO. :

THE DESIGN AND SPECIFICATION AS PRESENTED IN THIS DRAWING ARE PROPERTIES OF ANDEN CORPORATION CO., LTD. THEY ARE NOT ALLOWED TO BE USED WITHOUT PRIOR WRITTEN PERMISSION

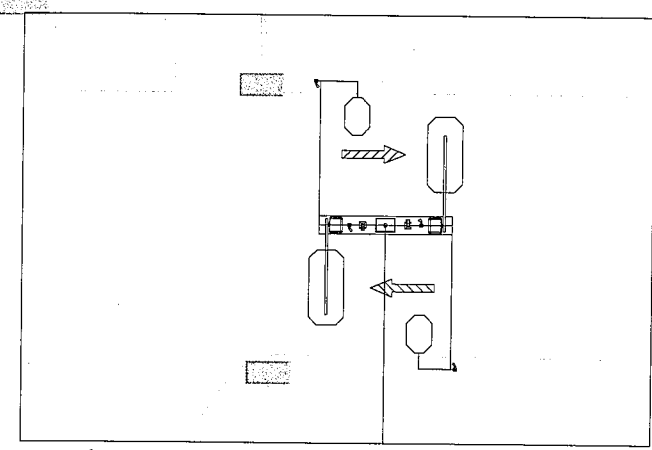
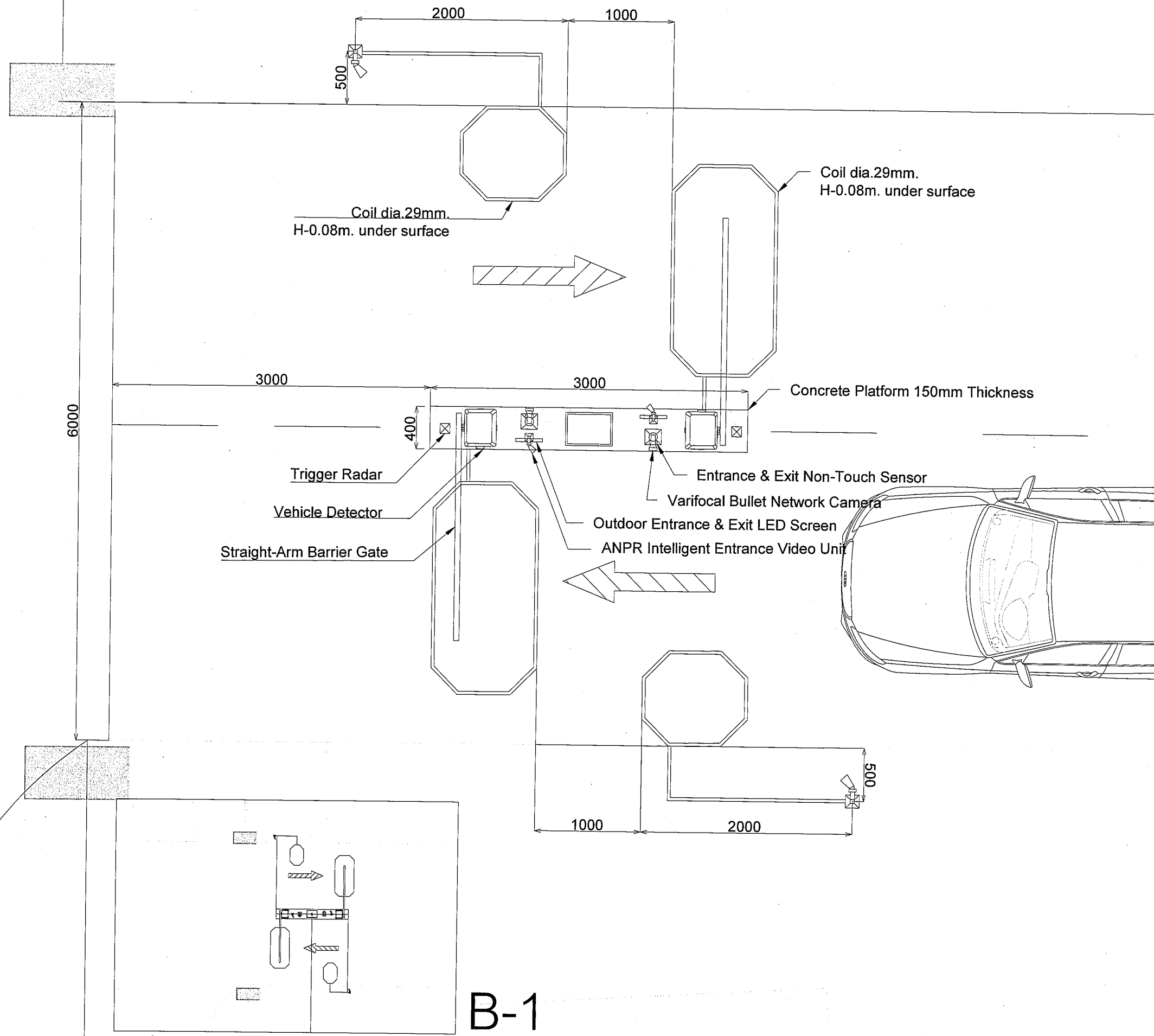

**B-1**

OWNER :	
APPROVED BY :	
PROJECT :	
LOCATION :	
PRESENTED BY :	
ANDEN CORPORATION COMPANY LIMITED 10/22, 10/23 Prawit Lae Phueon Alley, Lat Yao, Chatuchak, Bangkok 10900, Thailand	
DESIGNED BY :	
INTERIOR DESIGNER	
CIVIL ENGINEER	
MECHANIC ENGINEER	
ELECTRICAL ENGINEER	
SYSTEM DESIGNER	
DRAWN BY	
DESIGN DRAWING	
TITLE :	
SCALE	
REVISION	
DATE	
DRAWING NO. :	
SHEET NO. :	

THE DESIGN AND SPECIFICATION AS PRESENTED IN THIS DRAWING ARE PROPERTIES OF ANDEN CORPORATION CO., LTD. THEY ARE NOT ALLOWED TO BE USED WITHOUT PRIOR WRITTEN PERMISSION

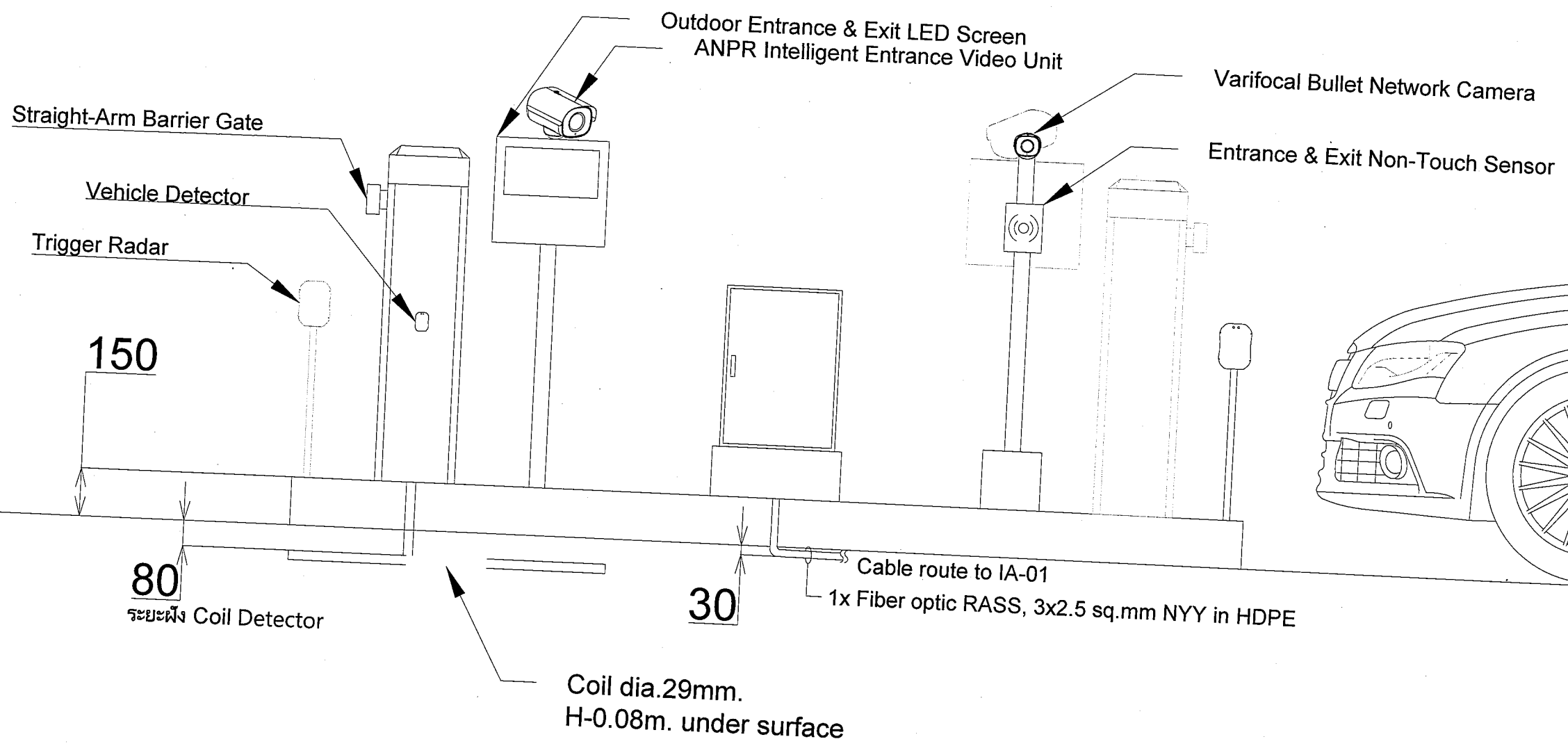

OWNER :

APPROVED BY :

PROJECT :

LOCATION :

PRESENTED BY :

ANDEN CORPORATION COMPANY LIMITED  
 10/22, 10/23 Prawat Loe Phuean Alley,  
 Lat Yao, Chatuchak, Bangkok 10900,  
 Thailand

DESIGNED BY :

INTERIOR DESIGNER

CIVIL ENGINEER

MECHANIC ENGINEER

ELECTRICAL ENGINEER

SYSTEM DESIGNER

DRAWN BY

DESIGN DRAWING

TITLE :

SCALE

REVISION

DATE

DRAWING NO. :

SHEET NO. :

THE DESIGN AND SPECIFICATION AS PRESENTED IN THIS DRAWING ARE PROPERTIES OF ANDEN CORPORATION CO., LTD. THEY ARE NOT ALLOWED TO BE USED WITHOUT PRIOR WRITTEN PERMISSION

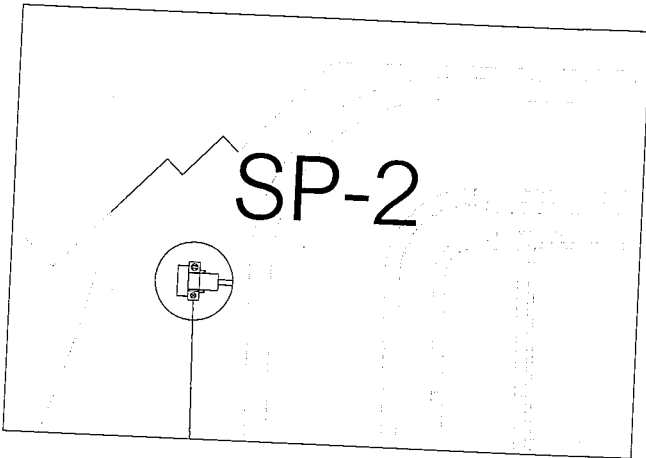

Cable route to SP-02

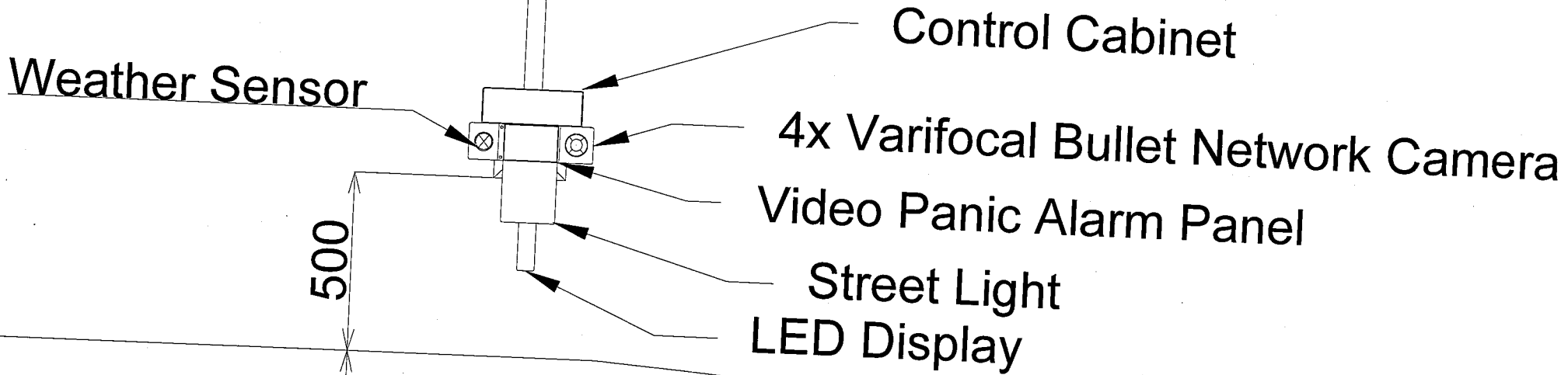

SP-2

OWNER :

APPROVED BY :

PROJECT :

LOCATION :

PRESENTED BY :

ANDEN CORPORATION COMPANY LIMITED  
10/22, 10/23 Prawat Lae Phuean Alley,  
Lat Yao, Chatuchak, Bangkok 10900,  
Thailand

DESIGNED BY :

INTERIOR DESIGNER	
CIVIL ENGINEER	
MECHANIC ENGINEER	
ELECTRICAL ENGINEER	
SYSTEM DESIGNER	
DRAWN BY	

DESIGN DRAWING

TITLE :

SCALE	
REVISION	
DATE	

DRAWING NO. :

SHEET NO. :

THE DESIGN AND SPECIFICATION AS PRESENTED IN THIS DRAWING ARE PROPERTIES OF ANDEN CORPORATION CO., LTD. THEY ARE NOT ALLOWED TO BE USED WITHOUT PRIOR WRITTEN PERMISSION

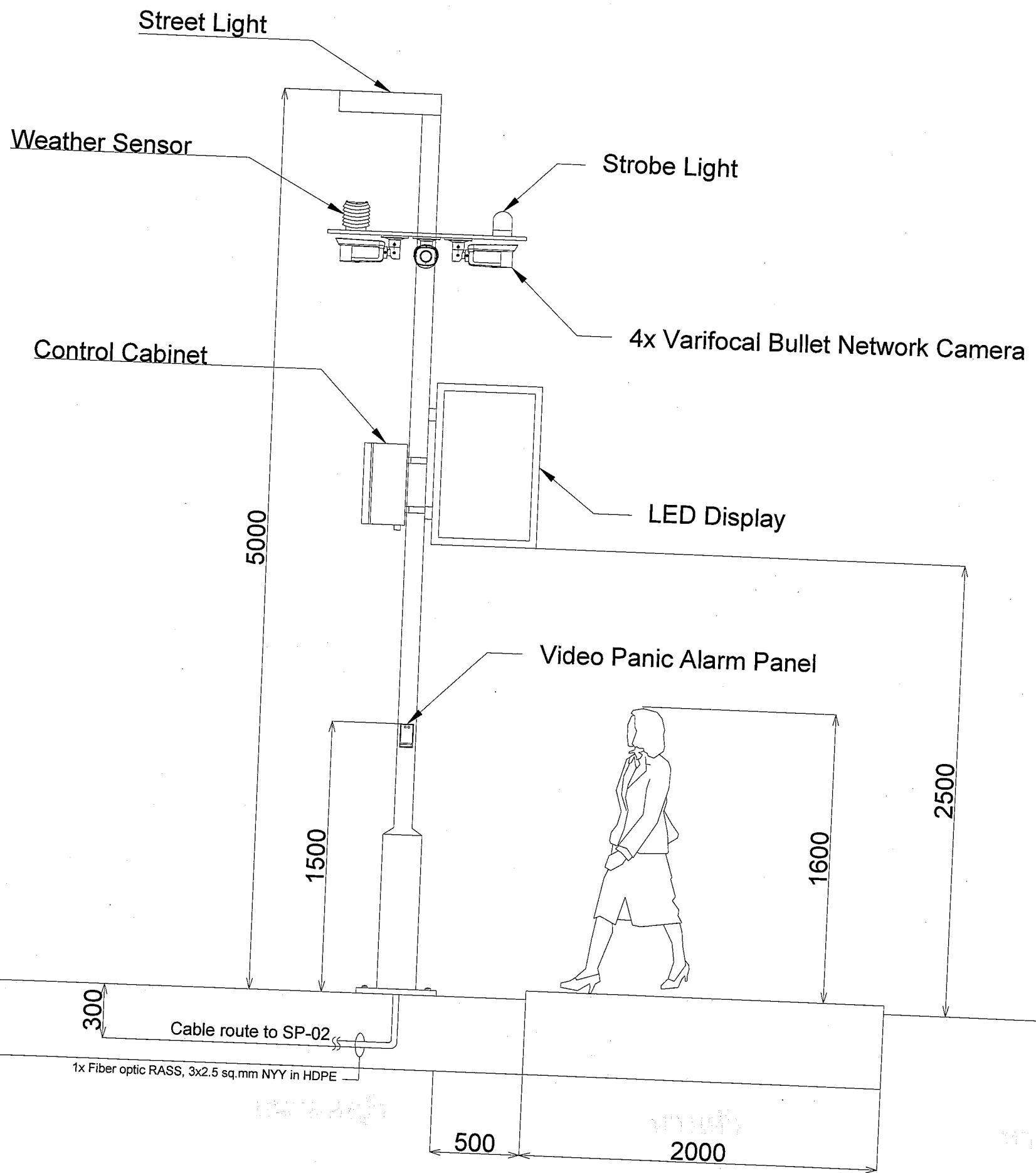

OWNER :

APPROVED BY :

PROJECT :

LOCATION :

PRESENTED BY :

ANDEN CORPORATION COMPANY LIMITED  
 10/22, 10/23 Prawat Lae Phuean Alley,  
 Lat Yao, Chatuchak, Bangkok 10900,  
 Thailand

DESIGNED BY :

INTERIOR DESIGNER	
CIVIL ENGINEER	
MECHANIC ENGINEER	
ELECTRICAL ENGINEER	
SYSTEM DESIGNER	
DRAWN BY	

DESIGN DRAWING

TITLE :

SCALE	
REVISION	
DATE	

DRAWING NO. :

SHEET NO. :

Note: ปรับพื้นที่ติดตั้งให้เหมาะสมสำหรับการติดตั้งเสาจับยึด

THE DESIGN AND SPECIFICATION AS PRESENTED IN THIS DRAWING ARE PROPERTIES OF ANDEN CORPORATION CO., LTD. THEY ARE NOT ALLOWED TO BE USED WITHOUT PRIOR WRITTEN PERMISSION



1/20

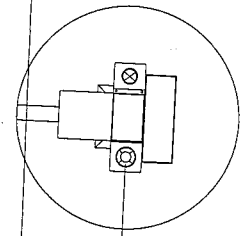

# SP-1

2-ค  
อาคารสมเด็จพระเทพฯ  
**AD-08**

ไฟ

สะพานลอยเหล็ก

OWNER :

APPROVED BY :

PROJECT :

LOCATION :

PRESENTED BY :

ANDEN CORPORATION COMPANY LIMITED  
10/22, 10/23 Prawit Lae Phuean Alley,  
Lat Yao, Chatuchak, Bangkok 10900,  
Thailand

DESIGNED BY :

INTERIOR DESIGNER

CIVIL ENGINEER

MECHANIC ENGINEER

ELECTRICAL ENGINEER

SYSTEM DESIGNER

DRAWN BY

DESIGN DRAWING

TITLE :

SCALE

REVISION

DATE

DRAWING NO. :

SHEET NO. :

THE DESIGN AND SPECIFICATION AS PRESENTED IN THIS DRAWING ARE PROPERTIES OF ANDEN CORPORATION CO., LTD. THEY ARE NOT ALLOWED TO BE USED WITHOUT PRIOR WRITTEN PERMISSION

กระถางคปเพลิง

หญ้า

สนามหญ้า

สนามหญ้า

หญ้า

# SP-2

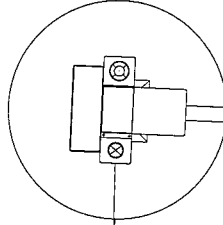

To Node at Building SP-02

ลานตากผ้า

อาคาร 5

OWNER :

APPROVED BY :

PROJECT :

LOCATION :

PRESENTED BY :

ANDEN CORPORATION COMPANY LIMITED  
10/22, 10/23 Prawat Lae Phuean Alley,  
Lat Yao, Chatuchak, Bangkok 10900,  
Thailand

DESIGNED BY :

INTERIOR DESIGNER	
CIVIL ENGINEER	
MECHANIC ENGINEER	
ELECTRICAL ENGINEER	
SYSTEM DESIGNER	
DRAWN BY	

DESIGN DRAWING

TITLE :

SCALE

REVISION

DATE

DRAWING NO. :

SHEET NO. :

THE DESIGN AND SPECIFICATION AS PRESENTED IN THIS DRAWING ARE PROPERTIES OF ANDEN CORPORATION CO., LTD. THEY ARE NOT ALLOWED TO BE USED WITHOUT PRIOR WRITTEN PERMISSION

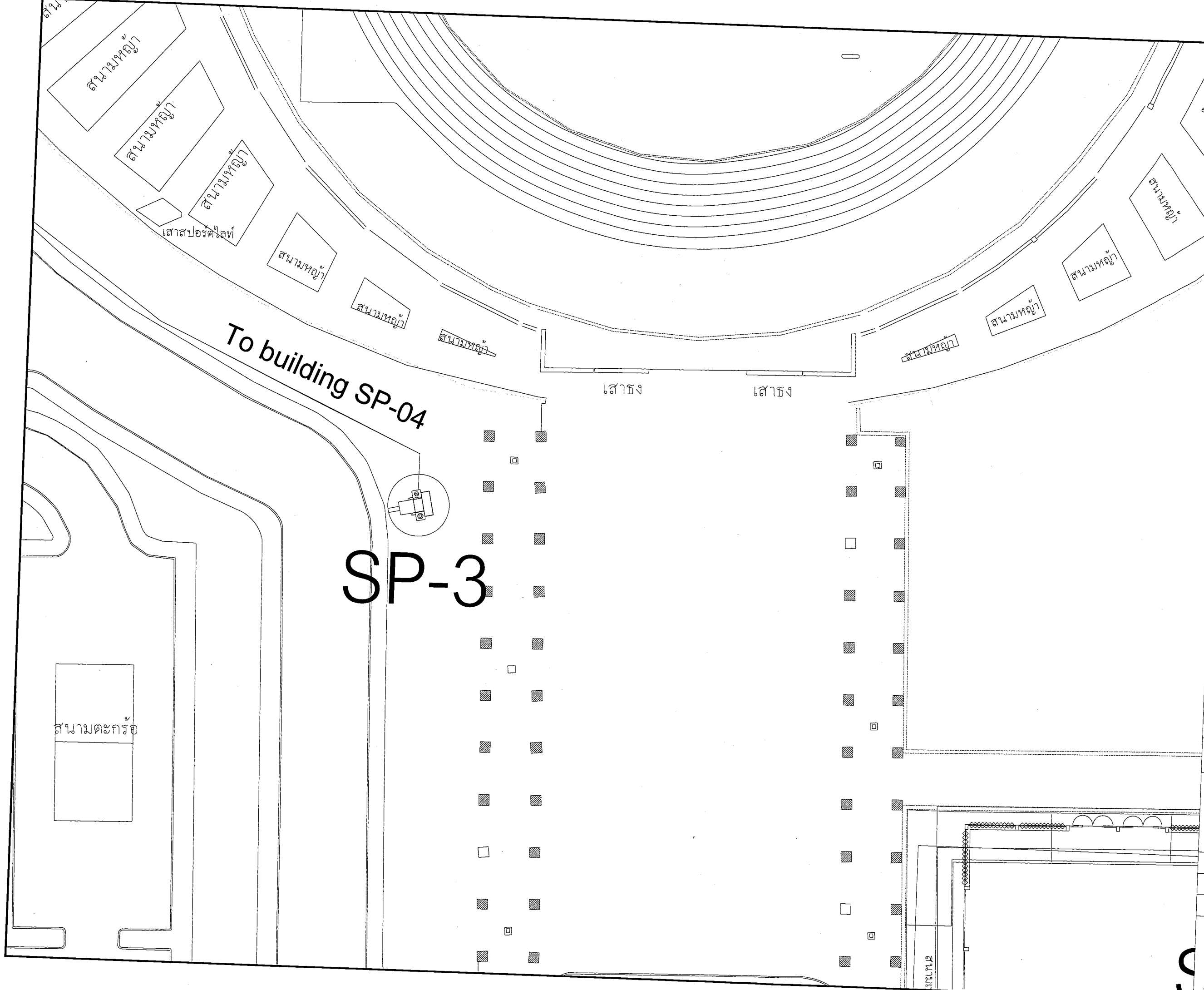

OWNER :

APPROVED BY :

PROJECT :

LOCATION :

PRESENTED BY :

ANDEN CORPORATION COMPANY LIMITED  
 10/22, 10/23 Prawat Lee Phuean Alley,  
 Lat Yao, Chatuchak, Bangkok 10900,  
 Thailand

DESIGNED BY :

INTERIOR DESIGNER	
CIVIL ENGINEER	
MECHANIC ENGINEER	
ELECTRICAL ENGINEER	
SYSTEM DESIGNER	
DRAWN BY	

DESIGN DRAWING

TITLE :

SCALE	
REVISION	
DATE	

DRAWING NO. :

SHEET NO. :

THE DESIGN AND SPECIFICATION AS PRESENTED IN THIS DRAWING ARE PROPERTIES OF ANDEN CORPORATION CO., LTD. THEY ARE NOT ALLOWED TO BE USED WITHOUT PRIOR WRITTEN PERMISSION.

1-ค  
ที่เก็บขยะ

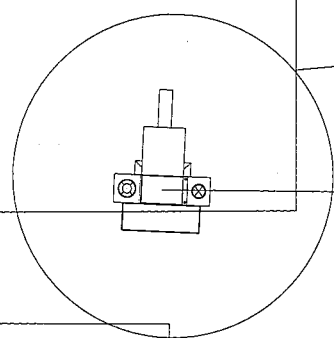

To building AG-07

1-ค  
ห้องเก็บของ

SP-4

เลขที่ 19  
โฉนดที่ดิน

OWNER :

APPROVED BY :

PROJECT :

LOCATION :

PRESENTED BY :

ANDEN CORPORATION COMPANY LIMITED  
10/22, 10/23 Prawit Loe Phuean Alley,  
Lat Yao, Chatuchak, Bangkok 10900,  
Thailand

DESIGNED BY :

INTERIOR DESIGNER	
CIVIL ENGINEER	
MECHANIC ENGINEER	
ELECTRICAL ENGINEER	
SYSTEM DESIGNER	

DRAWN BY

DESIGN DRAWING

TITLE :

SCALE

REVISION

DATE

DRAWING NO. :

SHEET NO. :

THE DESIGN AND SPECIFICATION AS PRESENTED IN THIS DRAWING ARE PROPERTIES OF ANDEN CORPORATION CO., LTD. THEY ARE NOT ALLOWED TO BE USED WITHOUT PRIOR WRITTEN PERMISSION



To building AG-07

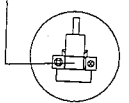

SP-5

PRESENTED BY :  
 ANDEN CORPORATION COMPANY LIMITED  
 10/22, 10/23 Prawit Loe Phuean Alley,  
 Lat Yao, Chatuchak, Bangkok 10900,  
 Thailand

DESIGNED BY :

INTERIOR DESIGNER	
CIVIL ENGINEER	
MECHANIC ENGINEER	
ELECTRICAL ENGINEER	
SYSTEM DESIGNER	
DRAWN BY	

DESIGN DRAWING

TITLE :

SCALE	
REVISION	
DATE	

DRAWING NO. :

SHEET NO. :

THE DESIGN AND SPECIFICATION AS PRESENTED IN THIS DRAWING ARE PROPERTIES OF ANDEN CORPORATION CO., LTD. THEY ARE NOT ALLOWED TO BE USED WITHOUT PRIOR WRITTEN PERMISSION

# สถานีรถไฟหัวตะเข้

1-ค  
ร้านค้า

ห้องน้ำ

1-ง

1-ง

SP-6

To C-5

C-5

OWNER :

APPROVED BY :

PROJECT :

LOCATION :

PRESENTED BY :

ANDEN CORPORATION COMPANY LIMITED  
10/22, 10/23 Prawat Loe Phueon Alley,  
Lat Yoo, Chatuchak, Bangkok 10900,  
Thailand

DESIGNED BY :

INTERIOR  
DESIGNER

CIVIL  
ENGINEER

MECHANIC  
ENGINEER

ELECTRICAL  
ENGINEER

SYSTEM  
DESIGNER

DRAWN BY

DESIGN DRAWING

TITLE :

SCALE

REVISION

DATE

DRAWING NO. :

SHEET NO. :

THE DESIGN AND SPECIFICATION AS PRESENTED IN THIS DRAWING ARE PROPERTIES OF ANDEN CORPORATION CO., LTD. THEY ARE NOT ALLOWED TO BE USED WITHOUT PRIOR WRITTEN PERMISSION

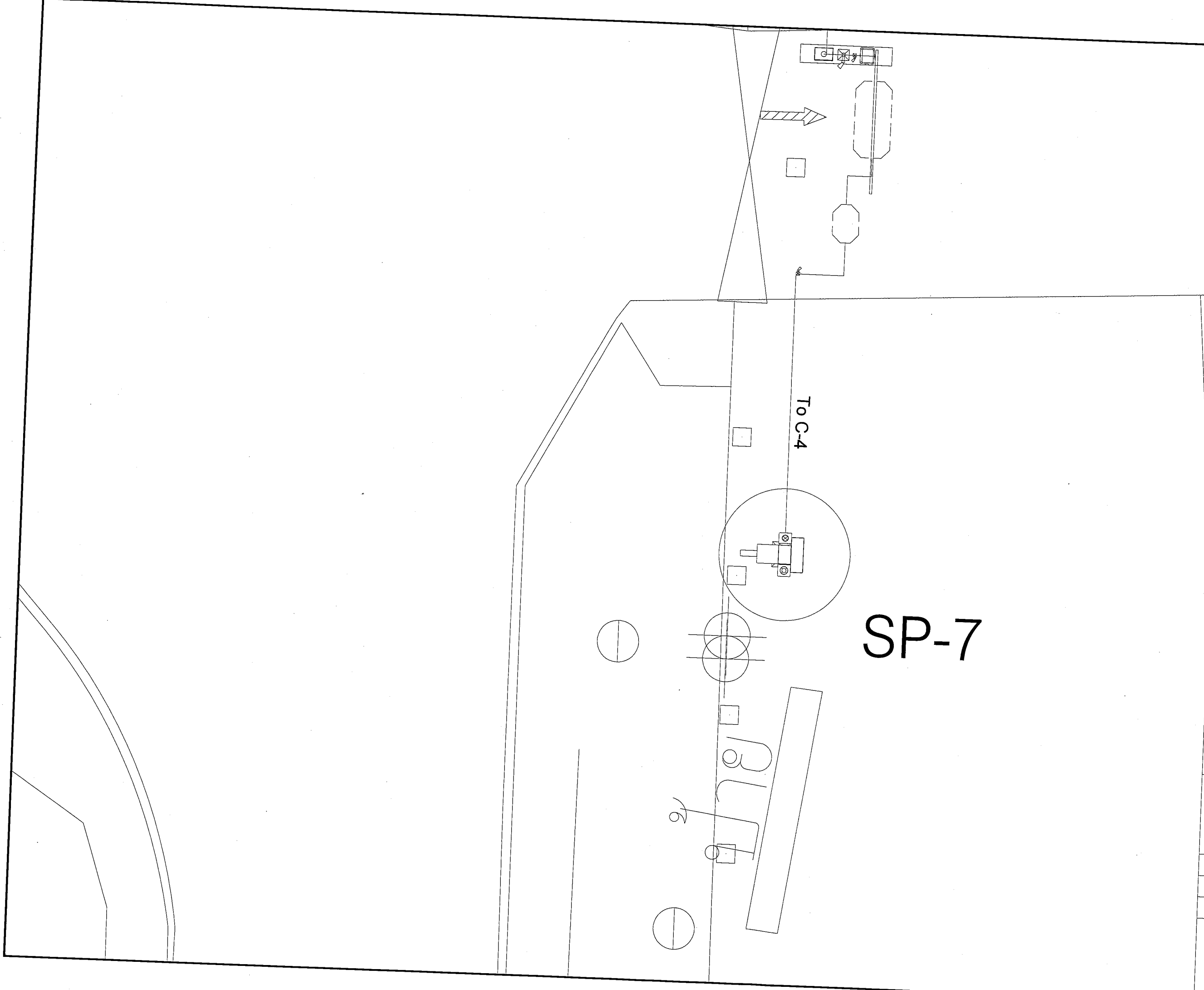

OWNER :

APPROVED BY :

PROJECT :

LOCATION :

PRESENTED BY :

ANDEN CORPORATION COMPANY LIMITED  
 10/22, 10/23 Prawat Lee Phuean Alley,  
 Lat Yao, Chatuchak, Bangkok 10900,  
 Thailand

DESIGNED BY :

INTERIOR  
 DESIGNER

CIVIL  
 ENGINEER

MECHANIC  
 ENGINEER

ELECTRICAL  
 ENGINEER

SYSTEM  
 DESIGNER

DRAWN BY

DESIGN DRAWING

TITLE :

SCALE

REVISION

DATE

DRAWING NO. :

SHEET NO. :

THE DESIGN AND SPECIFICATION AS PRESENTED IN THIS DRAWING ARE PROPERTIES OF ANDEN CORPORATION CO., LTD. THEY ARE NOT ALLOWED TO BE USED WITHOUT PRIOR WRITTEN PERMISSION

บ่อน้ำ

SP-8

2-ค  
รศิลปอุตสาหกรรม

AR-04

บ่อพักน้ำ

WL=0.44M.

ทางเดินเท้า

OWNER :

APPROVED BY :

PROJECT :

LOCATION :

PRESENTED BY :

ANDEN CORPORATION COMPANY LIMITED  
10/22, 10/23 Prawat Lae Phuean Alley,  
Lat Yao, Chatuchak, Bangkok 10900,  
Thailand

DESIGNED BY :

INTERIOR  
DESIGNER

CIVIL  
ENGINEER

MECHANIC  
ENGINEER

ELECTRICAL  
ENGINEER

SYSTEM  
DESIGNER

DRAWN BY

DESIGN DRAWING

TITLE :

SCALE

REVISION

DATE

DRAWING NO. :

SHEET NO. :

THE DESIGN AND SPECIFICATION AS PRESENTED IN THIS DRAWING ARE PROPERTIES OF ANDEN CORPORATION CO., LTD. THEY ARE NOT ALLOWED TO BE USED WITHOUT PRIOR WRITTEN PERMISSION



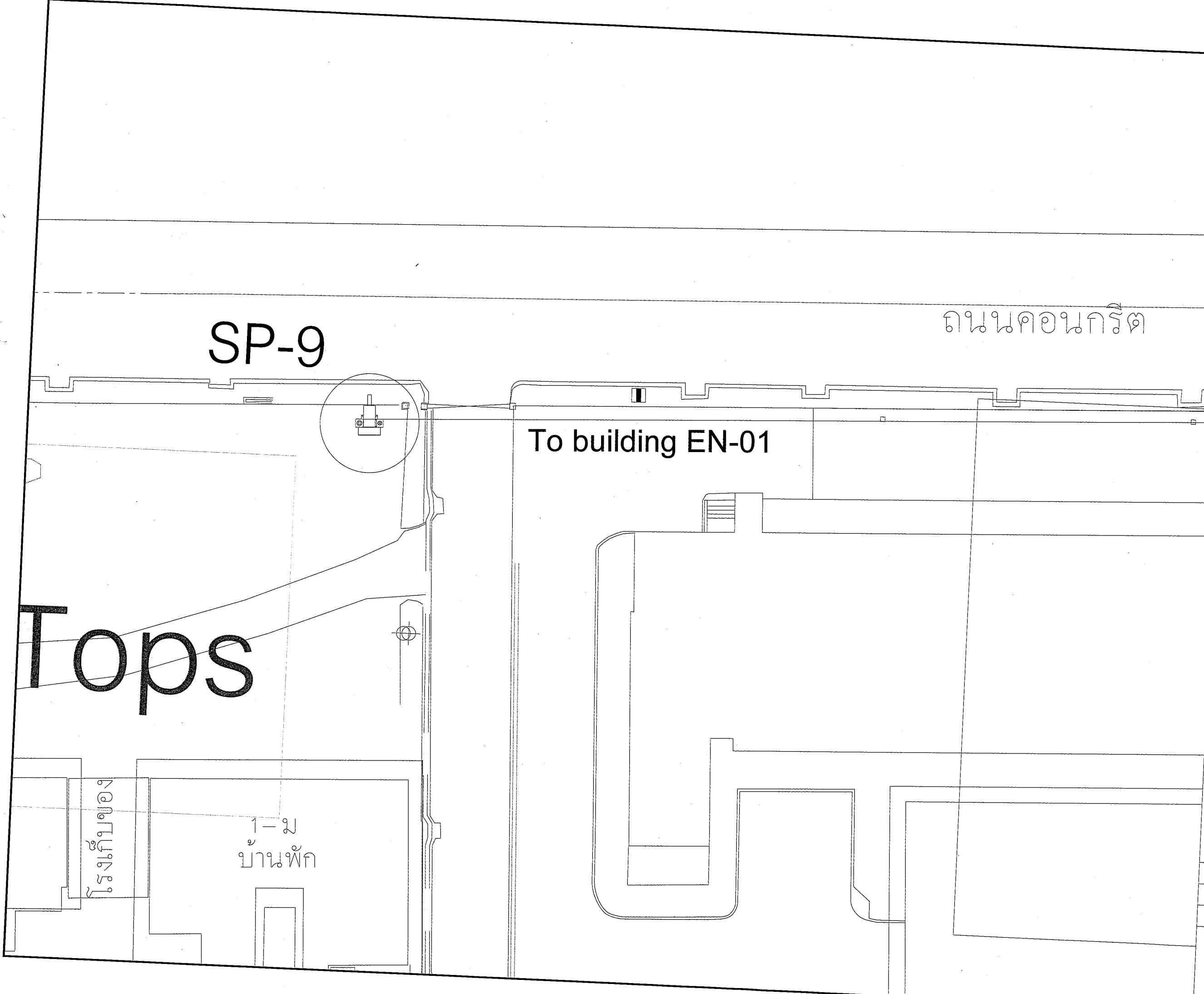

SP-9

ถนนคอนกรีต

To building EN-01

Tops

โรงเก็บของ

บ้านพัก

OWNER :

APPROVED BY :

PROJECT :

LOCATION :

PRESENTED BY :

ANDEN CORPORATION COMPANY LIMITED  
10/22, 10/23 Prawat Lae Phueon Alley,  
Lat Yao, Chatuchak, Bangkok 10900,  
Thailand

DESIGNED BY :

INTERIOR DESIGNER

CIVIL ENGINEER

MECHANIC ENGINEER

ELECTRICAL ENGINEER

SYSTEM DESIGNER

DRAWN BY

DESIGN DRAWING

TITLE :

SCALE

REVISION

DATE

DRAWING NO. :

SHEET NO. :

THE DESIGN AND SPECIFICATION AS PRESENTED IN THIS DRAWING ARE PROPERTIES OF ANDEN CORPORATION CO., LTD. THEY ARE NOT ALLOWED TO BE USED WITHOUT PRIOR WRITTEN PERMISSION